

# BRAKIT

## CONDENSER ARMS

### SP/254/SINGLE SERIES/1.2MM/1.6MM/2.0MM

DESCRIPTION	A (MM)
SP/254/450	450
SP/254/550	550
SP/254/600	600
SP/254/650	650

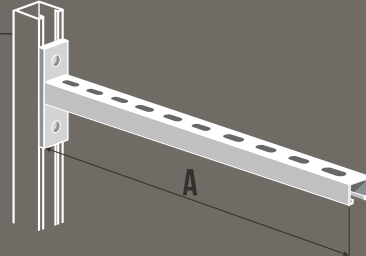

### SP/254/S SERIES/2.0MM

DESCRIPTION	A (MM)
SP/254/S/650	650
SP/254/S/850	850
SP/254/S/1050	1050

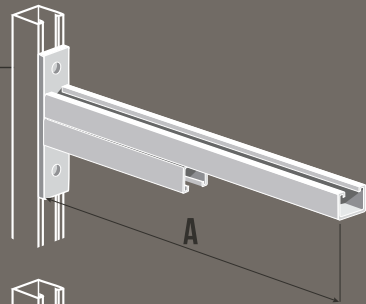

### SP/254/FULL DOUBLE SERIES/2.0MM

DESCRIPTION	A (MM)
SP/254/F/850	850
SP/254/F/1050	1050

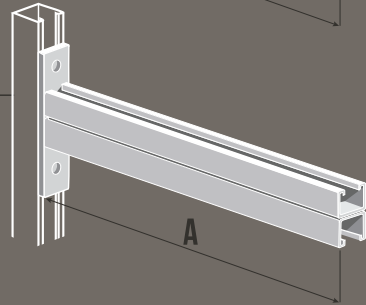

## BOXED KITS MADE TO SPEC

### BOX



### FIXING KIT

- RAWL BOLTS
- HEX SETS
- SPRING NUTS
- HEX NUTS
- WASHERS

### ALSO AVAILABLE IN WRAP C/W BACKING

DESCRIPTION	A (MM)
SP/223/450	450
SP/223/550	550
SP/223/600	600
SP/223/650	650

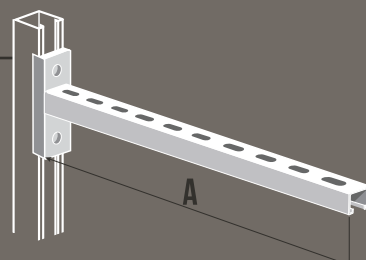

STANDARD HOT DIPPED GALVANIZED OR POWDER COATED

# BRAKIT

## POWA/SUPA ARMS

### POWA ARM/SP/254/SINGLE SERIES/2.0MM

DESCRIPTION	A (MM)
PA/450/450	450
PA/550/580	580
PA/600/580	580
PA/650/700	700

### POWA ARM/SP/254/S SERIES/2.0MM

DESCRIPTION	A (MM)
PA/650/450	450
PA/850/450	450
PA/1050/450	450

### SUPA ARM/SP/254/FULL DOUBLE SERIES/2.0MM

DESCRIPTION	A (MM)
SA/850/1200	1200
SA/1050/1200	1200

STANDARD HOT DIPPED GALVANIZED OR POWDER COATED

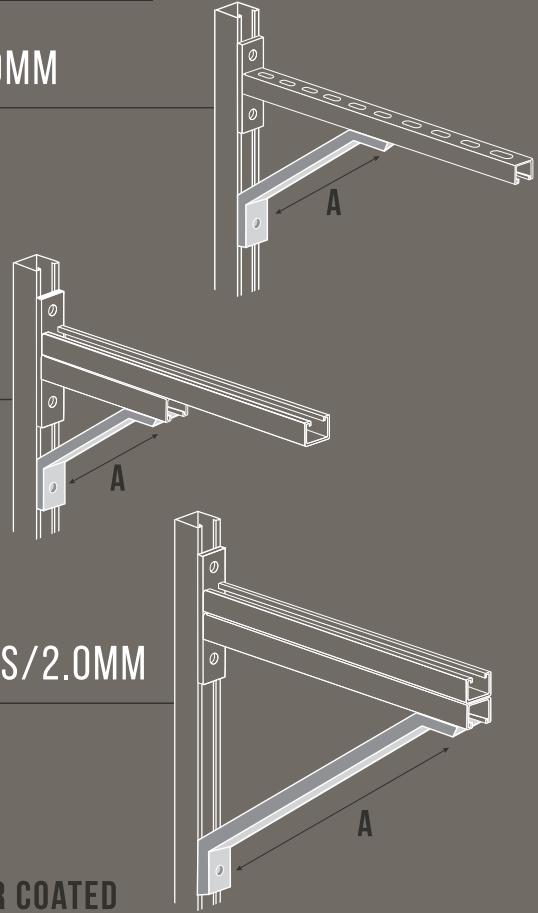

## ACCESSORIES

### STRUT CHANNELS

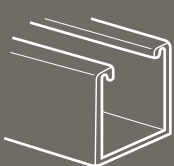

REF: 1000

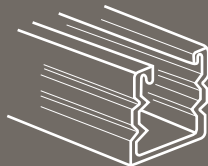

REF: 2000

### FASTENERS



HEX SET BOLT



FLAT WASHER



SPRING WASHER



FENDER WASHER



HEX NUT



THREADED ROD

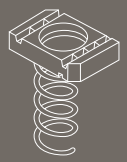

SPRING NUT



RAWL BOLT

### ANGLE BRACKETS

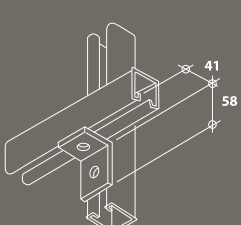

1068

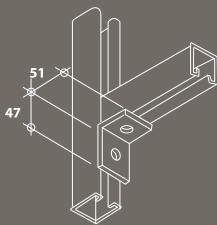

1026

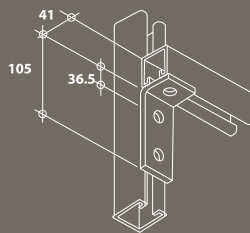

1326

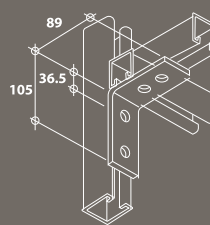

1325

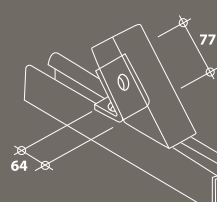

1186-45°

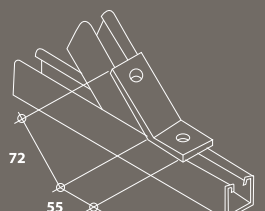

1546-45°